



40H Series

Heavy Duty Mortise Locks



BEST: Setting the Standard for Security

TABLE OF CONTENTS

Features 2
 Specifications 3-4
 Universal Lock Concept 4
 How To Order 6-8
 Special Features 8
 Service Equipment 9
 Hand of Door 9

Mortise Sample Specification 9-10
 Levers, Knobs & Trims 10-13
 Functions 14-18
 48H & 49H High Security Specification 18
 48H & 49H Function & How To Order 19
 Standard & High Security Cylinders 19-20

Features

1. Solid one-piece stainless steel anti-friction latch provides 50% more surface contact with strike for superior strength and security. Reversible latch rotates 180 degrees for easy handing change without opening case. Precision-engineered curve provides enhanced cycle life with reduced wear to the strike.
2. Non-handed cylinder retainer.
3. Armored front completely surrounds latch and deadbolt providing increased lateral strength. Staked assembly design allows the armored front to self-align with the door bevel during installation.
4. Enhanced case integrity achieved through four case cover screws (one at each corner), plus interlocking armored front and cover design at the latch.
5. Roller bearing hub mechanism provides smooth, wear resistant operation.
6. Locking toggle includes clear indication of "locked" and "unlocked" states.
7. 40H case, cover, and armored front manufactured from 0.095" cold rolled steel for strength and durability.
8. Fusible link.
9. Four position hub toggle design determines whether each hub is always locked, always unlocked, or locked by key for easy handing change without opening case.
10. Lever return spring mechanism located in trim for enhanced protection against lever droop, providing a firm, positive return of the lever to the horizontal position.
11. Self-aligning trim mechanism for fast, easy, and accurate installation.
12. Curved lip strike and strike box assembly provides an aesthetic, non-handed solution to complement field reversible case.
13. Solid machined cylinder rings with wavy washer provides resistance to wrenching of cylinder. Cylinder security screw prevents removal of cylinder without first removing interchangeable core.
14. Visual indicator options show a padlock icon open for unlocked and padlock icon closed and painted red for locked.
15. Non-handed stainless steel auxiliary bolt for ease of changing hand. (not shown)

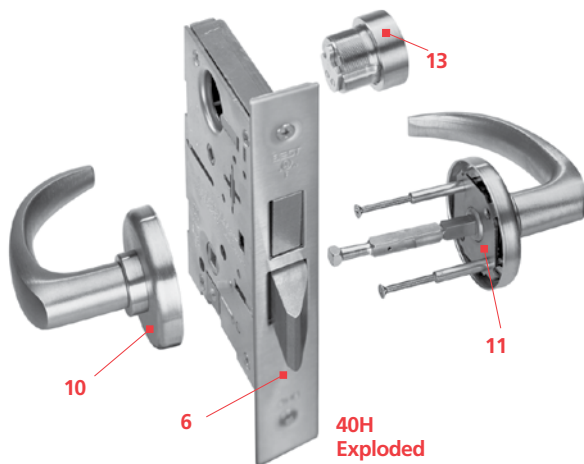
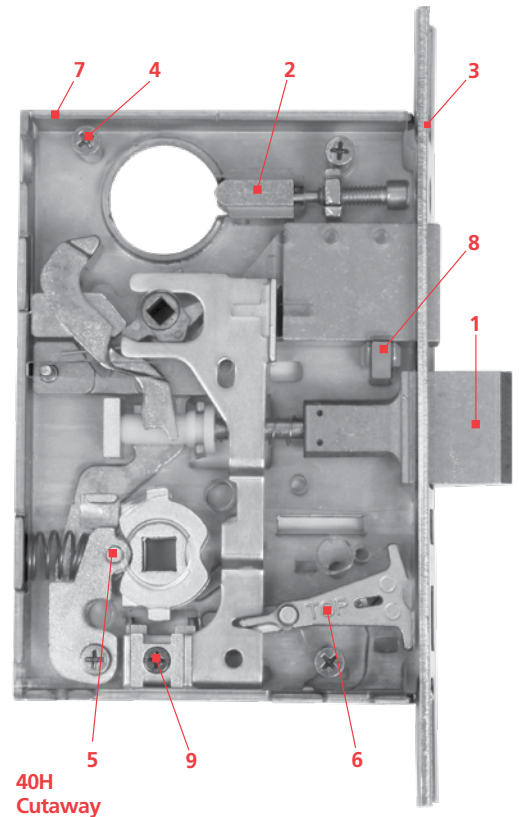



Specifications

ADA-Americans With Disabilities Act:

45H Series – The design and operation of the BEST® mortise lock meets the intent of the standard for ANSI A117.1 section 404.2.6.

Builders Hardware Manufacturers Association:

45H Series – ANSI A156.13, Series 1000, Grade 1 Operation and Strength, Grade 2 Security. To meet Grade 1 Security, a drill resistant core (1CD, 1CDP, 1CDF, or 1CDX) must be used with escutcheon trims, and 1EK7K4 high security cylinder must be used with sectional trims.

47H Series – ANSI A156.13, Series 1000, Grade 1 Operational, Strength, and Security.

Underwriters Laboratories® – The 40H series is listed by Underwriters Laboratories for use on a 3 hour A label doors. These locks also carry the C-UL mark which is officially accepted in all of Canada, indicating compliance with appropriate Canadian standards and codes. The 47H series locks conform to UL437 standard for key locks, referencing door locks. The 1EJ7J4 cylinder used in the 47H series also conforms to UL437 standard for key locks, referencing high security cylinders, and is listed for Canada as well as the United States.

Florida Building Code (FBC) Listed and Miami-Dade County Code Compliance Office – See certification listing for all 40H series lock functions that are certified for use in applications requiring a design pressure rating as specified.



Description	Model	Single Door	Double Door
PSF w/o DeadBolt	45H and 47H	+60	+35
PSF w/ DeadBolt	45H and 47H	+100	+50
PSF w/ DeadBolt	48H and 49H	+50	+50

The 40H series lock has received a notice of acceptance from Miami-Dade County and is considered Miami-Dade County product. “WS” option must be ordered for the lock to include a “Miami-Dade County Product Control Approved” label for inspection purposes.

Auxiliary bolt – Stainless steel, non-handed.

Backset – 2 3/4”

Case – 0.095” cold rolled steel, 5 7/8” H x 7/8” D x 4 1/16” W. Steel is zinc dichromate plated for corrosion protection.

Deadbolt – Stainless steel, 1” throw.

Latchbolt – Solid stainless steel, 3/4” throw. Latch is oil-impregnated for anti-friction operation. Reversible without opening case.

Strike – For complete strike package spec’s see page 5.

Door Thickness – Standard lock configuration designed for doors 1 3/4” thick. Thick door configuration available for doors up to 5” thick (specify thickness when ordering).

Faceplate – Stainless steel, brass or bronze material, 8” H x 1 1/4” W x 1/16” T. Lock face automatically adjusts to proper bevel during installation.

Products protected by one or more of the following patents:

4,873,853 5,590,555 5,794,472

Finishes –

- 605 – bright brass, clear coated
- 606 – satin brass, clear coated
- 611 – bright bronze, clear coated
- 612 – satin bronze, clear coated
- 613* – oxidized satin bronze, oil rubbed
- 618 – bright nickel plated, clear coated (brass base material)
- 619 – satin nickel plated, clear coated (brass base material)
- 622 – flat black coated (brass base material)
- 625 – bright chromium plated (brass base material)
- 626 – satin chromium plated (brass base material)
- 629 – bright stainless steel
- 630 – satin stainless steel
- 690* – dark bronze coated (brass base material)

*613 finish is designed to wear over time, providing an “antique” appearance.

*690 finish will continue as a dark brown appearance over time.

Antimicrobial Finish –

- 626AM – satin chrome plated with UltraShield™ antimicrobial protected coating
- 630AM – satin stainless steel with UltraShield™ antimicrobial protected coating



The BEST UltraShield finish inhibits the growth of bacteria and other microbes on the surface of the hardware.

NOTE: BEST UltraShield™ option is recommended for use on any hardware application where product cleanliness is a high priority. i.e.: Hospital/Healthcare, Elderly Care, Education, Transportation, Food-Service, Hospitality.

Specifications

#4 Knob – Diameter – 2 1/8" ; Projection on door – 2 7/8" Material machined from solid brass or bronze.

Decorative and Special Order Lever Handles – Stainless steel base material with applied finish.

Standard Lever Handles – Brass, bronze, or stainless steel base material for standard lever designs. Lever styles #3, #14, and #15 return to a minimum of 1/2" of door surface. Lever styles #3 and #14 conform to California Titles 19 and 24. Lever styles 12, 16 and 17 do not return. Levers project 2 15/16" from door surface with H, J, R and S trim. Levers project 3 1/64" with M and N trim.

Roses – Wrought brass, bronze, or stainless steel base material.

H – Flat w/ round edge, 2 3/4" diameter.

R – Contoured w/ round edge, 2 3/4" diameter.

S – Flat w/ beveled edge, 3 1/2" diameter.

Escutcheons – J – Wrought brass, bronze, or stainless steel base material, 7 1/2" H x 2 9/32" W x 17/32" T. M & N – Forged brass or bronze, 8" H x 2 1/8" W x 37/64" T, through bolt mounted (no exposed screws outside). M – Standard cylinder; N – Concealed cylinder.

Vandal Trim – VT–Vandal trim is available in standard finish for H, J, M, N, R, and S trims in either #14 or #15 levers.

NOTE: Not available in single or dummy trim functions. If compliance to California Building Code Title 19 & 24 is required, the #14 lever design must be specified.

Visual Indicators – VIN–Visual indication uses an unlocked padlock or locked padlock image with red background to indicate lock state. VIT–Visual indication uses a thumb-turn with color coded locked and unlocked icons – red indicates door is secure and green indicates door is unsecure.

Universal Lock Design Concept

Strength, Durability...and now Flexibility. Sure, a mortise lock is one of the strongest and longest lasting locks available. But who says it has to be the most complex to order and install? When designing the 40H mortise lock, BEST® decided to focus on things that would make the lock easier to use, while at the same time maintaining the strength, durability, and dependability you would expect in a BEST® mortise lock.

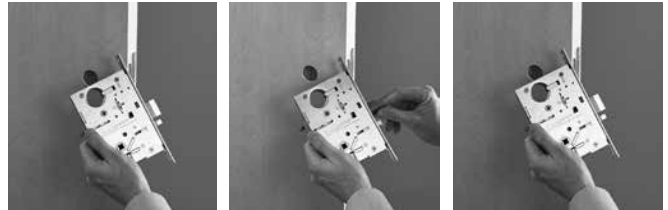

In addition to the ability to quickly change the lock handing, the universal case design of the 40H provides the ability to reconfigure a lock into many different functions easily and quickly, often by rearranging existing parts without disassembling the lock case. The efficiency of the design enables over 12 of the most commonly used lock functions to be included in just 3 case configurations.

The 40H provides the ability to postpone decisions on how the lock will be configured all the way up to the point of installation, making it one of the most flexible and user-friendly mortise locks available. This translates into value for anyone involved in the process, whether they're an architect, specification writer, distributor, or end-user.

Flexibility in Ordering

BEST offers three ways in which to order the 40H mortise lock. YOU get to choose which method meets your needs.

Function Specific Lock - If you know exactly what you need in a mortise lock, and are confident that your needs won't change, then order your 40H locks in the traditional way by specifying the exact function, trim, finish, and handing. BEST® will build the locks to work exactly as specified, so they may or may not have the ability to be converted to another function in the future.

Universal Lock - If you want to keep your options open, this method of ordering the 40H is for you. BEST® has developed three "universal" functions that can be configured to a variety of common functions, all without opening the lock case. When any of the universal functions are ordered as a complete lock, all the necessary parts (including trim) are provided to configure any of the functions in that group. Universal locks can only be ordered with sectional trim. If escutcheon trim is needed, order a three-part lock.

UNR	ANSI	UNT	ANSI	UNAB	ANSI
A – office	F04	L – privacy	F19	AB – office	F20
AT – office	F04	T – dormitory	F13	TA – dormitory	F12
D – storeroom	F07			TD – dormitory	
N – passage	F01				
NX – exit	F31				
R – classroom	F05				

Four-Part Lock - For the maximum flexibility in ordering a mortise lock, BEST® provides a way to order your 40H lock in four parts: Inside Trim, Case Only, Outside Trim and Strike Packages. The kits that make up these four parts have been carefully designed so that when all three are combined you have everything found in a complete 40H lock. This order method is ideal for customers wanting to stock a variety of trim designs with a minimal number of lock cases.

Parts Ordering Made Easy - No more searching through service manuals or calling technical support for the right part numbers. BEST® has developed a variety of kits you can order when you only need part of a 40H mortise, rather than the whole lock.

Case Only - A Case Only lock includes all parts normally included with a complete lock that are not specifically associated with either the inside or outside trim, including: lock case, face plate, strike and strike box, fasteners (for case and strike), and installation instructions.

Case Only mortise locks will be shipped in the standard mortise packaging, allowing trim kits to be included at a future date to make a complete lock.

Trim Kit - A 40H Trim Kit is simply one half of a complete trim package. An Outside Trim Kit must always be matched up with an Inside Trim Kit to operate with a lock. Each kit includes all the necessary parts (including fasteners) required for installation that are associated with just the one side of the door.

Lever Set - A lever set kit provides the inside lever assembly (with set screw) and outside lever assembly (with spindle attached). Thick Door and Tactile Lever options are available for this kit.

Faceplate Kit - Face Plate kit includes a finished faceplate and the appropriate screws. Security Head screws are an option for this kit.

Replacement Spindle - As a security feature, the outside spindle on the 40H is designed to twist off during abuse before any internal damage to the lock occurs. The Replacement Spindle kit is a quick, easy, and inexpensive way to replace any spindles damaged by attack or abuse. This kit includes the inside and outside spindles, plus the pin to attach the outside lever.

Screw Kit - Nothing's more frustrating than spending time searching for the part number of a single screw. With the 40H Screw Kits, you don't have to worry about that anymore. These kits have been designed to provide all the necessary fasteners for one lock in a single bag. All you need to know is the trim style and finish, and you're set. Security head screws are an option for this kit.

FOUR-PART LOCK

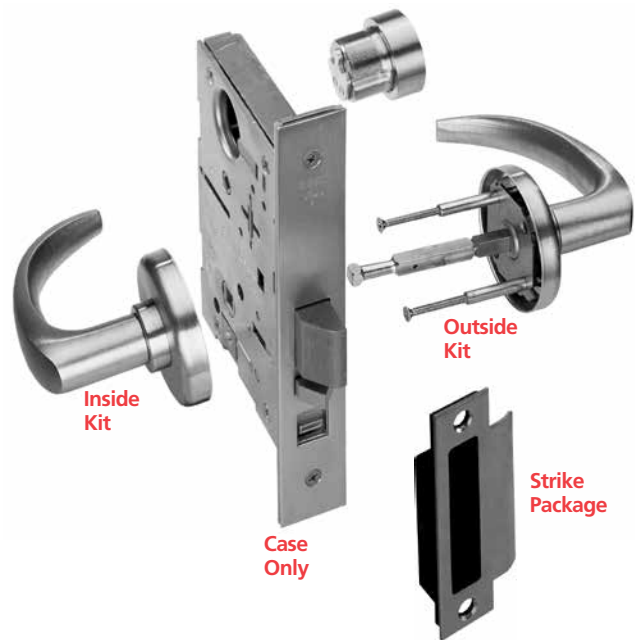

Function Letter Chart

ANSI	45H/47H	ANSI	45H/47H
	1DT	F19	L
	2DT	F02	LB
F04	A		LT
F20	AB	F01	N
F04	AT	F31	NX
F21	B	F05	R
	B5	F06	RHB
	B7	F35	S
F08/F10	BA	F13	T
	BW	F12	TA
F09	C		TD
	CHB	F30	W
F07	D	F17	AD
F14	G	F29	RD
F15	H	F16	WD
F15	HJ	F18	YD
F34	INA		UNR
F33	IND		UNT
F32	INL		UNAB

Strike Packages



S1 – Standard strike: 4 7/8" x 1 1/4" x 3/32", non-handed, curved lip, 1 1/4" lip to center strike. Fits standard door frame ANSI A115.1, and comes with plastic strike box.



S5 – Latchbolt-only strike: 4 7/8" x 1 1/4" x 3/32", handed, curved lip, 1 1/4" lip to center strike. Fits standard door frame ANSI A115.1, and comes with wrought steel strike box.



S6 – Latchbolt/Deadbolt strike: 4 7/8" x 1 1/4" x 3/32", handed, curved lip, 1 1/4" lip to center strike. Fits standard door frame ANSI A115.1, and comes with wrought steel strike box.

How to Order

How to order: 45H

45H	7	R	14	H	626	RH	
Series	Core Housing	Function Code	Lever Style	Trim Style	Finish	Door Hand	Options
45H– standard mortise lock	0– non keyed or dummy trim 7– 7 pin housing accepts all BEST cores	A– office D– storeroom L– privacy N– passage R– classroom T– dormitory etc.	Standard Levers: ♿3– solid tube/return ♿12– solid tube/no return ♿14– curved return ♿15– contour/angle return ♿16– curved/no return ♿17– gull wing Knobs: 4– round	H– 2 3/4" dia. R– 2 3/4" dia. S– 3 1/2" dia. J– wrought M– forged N– forged (concealed cyl.)	618 626 630 690 Satin 606 612 613 619 Bright 605 611 622 625 629 Antimicrobial 626AM 630AM	RH RHRB LH LHRB	LL– lead lined SH– security head screws Thick Door– (specify thickness if other than 1 3/4") TAC– tactile lever/knob 7/8 LTC– 7/8" lip-to-center strike VIN*– visual indicator S1– standard strike S5– latchbolt-only strike S6– latchbolt/deadbolt strike VT– vandal trim VT*– visual indicator thumb-turn VIB*– double visual indicator WS– windstorm label
			pages 15-18		page 3	page 9	

How to order: 47H

47H	7	R	14	M	626	RH	
Series	Core Housing	Function Code	Lever Style	Trim Style	Finishes	Door Hand	Options
47H– lever / knob high security mortise lock	7–7 pin housing, must use 5C cores and long blade keys	A– office D–storeroom R–classroom T– dormitory etc.	Standard Levers: ♿3– solid tube/return ♿12– solid return no return ♿14– curved return ♿15– contour/angle return ♿16– curve/no return ♿17– gull wing Knobs: 4– round	H– 2 3/4" dia. R– 2 3/4" dia. S– 3 1/2" dia. M– forged	626 630 Antimicrobial 626AM 630AM	RH RHRB LH LHRB	K– non UL cylinder LL– lead lined Thick Door– (specify thickness if other than 1 3/4") TAC– tactile lever/knob 7/8 LTC– 7/8" lip-to-center strike VIN*– visual indicator S1– standard strike S5– latchbolt-only strike S6– latchbolt/deadbolt strike VT– vandal trim WS– windstorm label
			pages 15-18		page 3	page 9	

*VIT option only compatible with H, R, S, J & M trim styles. VIN & VIB options only compatible with H, R & J trim styles.

How to order: 45H Case Only

45HCA	R	626	RH	
Series	Function Code	Finishes	Door Hand	Options
45HCA– case only mortise lock	A– office D– storeroom R– classroom T– dormitory etc.	605 606 611 612 613 618 619 622 625 626 629 630 690	RH RHRB LH LHRB	SH– security head screws 7/8 LTC– 7/8" lip-to-center strike
	pages 15-18	page 3	page 9	



How to order: 40H Trim Kits

40HTK	OS2	14	H	626	
Series Backset	Function Code	Lever/Knob Style	Trim Style	Finishes	Options
40HTK– trim kit	IS1– inside lever only IS2– inside lever x thumb turn IS3– inside lever x cylinder IS4*– inside cylinder only IS5– inside thumb turn only IS6– inside lever x cylinder x VIN OS1– outside lever only OS2– outside lever x cylinder OS3– outside lever x emergency plate OS4*– outside cylinder only OS5– outside lever x VIN OS6– inside lever x cylinder x VIN NOTE: VIN– visual indicator	Standard Levers: ⌘3– solid tube/return ⌘12– solid tube no return ⌘14– curved return ⌘15– contour/angle return ⌘16– curve/no return ⌘17RH– gull wing right hand ⌘17LH– gull wing left hand Knobs: 4– round	H– 2 3/4" dia. R– 2 3/4" dia. S– 3 1/2" dia. J– wrought M– forged N– forged (concealed cyl.)	605 606 611 612 613 618 619 622 625 626 629 630 690	D– double cylinder Thick Door– (specify thickness if other than 1 3/4") SH– security head screws TAC– tactile lever/knob
pages 15-18				page 3	

* Only works with H, R, S, M and N trim.

How to order: 40H Strike Packages

40HST	S1	626				
Series	Kit Number	Finishes				Options
40HST– strike package	S1– standard strike S5– latchbolt-only strike S6– latchbolt/deadbolt strike 4– strike box only	605 606 611 612 613 618 619 622 625 626 629 630 690				Thick Door– (specify thickness if other than 1 3/4") 7/8LTC– 7/8" lip-to-center strike SH– security head screws
page 5		page 3				

How to order: 40H lever sets

40HLS	14	626				
Series	Kit Number	Finishes				Options
40HLS– lever set	Levers: ⌘3– solid tube/return ⌘12– solid tube/no return ⌘14– curved return ⌘15– contour/angle return ⌘16– curve/no return ⌘17RH– gull wing-right hand ⌘17LH– gull wing-left hand Knobs: 4– round Decorative & special order levers: pages 12-14	605 606 611 612 613 618 619 622 625 626 629 630 690				Thick Door– (specify thickness if other than 1 3/4") SH– security head screws VT– vandal trim
page 5		page 3				

How to order: 40H Faceplate Kits

40HFP	3	626				
Series	Kit Number	Finishes				Options
40HFP– faceplate kit	0– AB 1– BW, TD, H, HJ 2– A 3– AT, D, C, INL, NX, R, W 4– N, LT 5– AD, RD, YD, WD	6– blank 7– BA, S, TA 8– B, G, IND, L, LB, T 9– CHB, RHB 10– blank (without logo)	605 606 611 612 613 618 619 622 625 626 629 630 690			Thick Door– (specify thickness if other than 1 3/4") 7/8LTC– 7/8" lip-to-center strike SH– security head screws
page 5		page 3				

How to Order

How to order: 40H Replacement Spindles

40HRS	2	
Series	Function Code	Options
40HRS– replacement spindle kits	2– 40H split spindle (standard) 4– 40H hook spindle *	Thick Door– (specify thickness if other than 1 3/4") *Hook spindle is available for 1 3/4" thick door only.
	page 5	

How to order: 40H Vandal Trim Retrofit Kit

40HVTK	14	626	
Series	Lever Style	Finishes	Options
40HVTK– vandal trim	♿14*– curved return ♿15– contour/angle return	605, 606, 611, 612, 613 618 619, 622, 625, 626, 629, 630, 690	Thick Door– (specify thickness if other than 1 3/4")

*Complies with California Building Code Title 10 and Title 24, part 12

How to order: 40H Screw Kits

40HSK	1	626	
Series	Kit Number	Finishes	Options
40HSK– screw kits	1– H, R, S, J trim screw kit 2– M, N trim screw kit 3– special purpose fasteners screw kit 4– surface mounted trim screw kit 5– VIN trim screw kit page 5	606 612 613 622 626 page 3	Thick Door– (specify thickness if other than 1 3/4") SH– security head

How to order: 40H Visual Indicator Laminate & Thumb-turn

Part Description	Part Number	Series	Trim Style	Finishes	Options
Indicator Laminate		Indicator Thumb-turn			
Thumb-turn Indicator Kit	86329	40HVIT	H– 2 3/4" Dia. R– 2 3/4" Dia. S– 3 1/2" Dia. M– forged J– wrought	605 606 611 612 613 618 619 622 625 626 629 630 690 626AM 630AM	Thick Door– (specify thickness if other than 1 3/4")
Thumb-turn Escutcheon Indicator Kit	86829				

Special Features

Lead Lined Feature

The 40H mortise lock can be lead lined to protect against x-rays. Since the majority of lead lined doors contain the lead in the surface of the door, the 40H provides lead lining for the holes cut in the door when preparing the door for the trim. The cylinder hole is lead lined.

To order: designate "LL" on order procedure (page 6-7)

Security Head Screws

Security head screws.

To order: designate "SH" on 45H/47H in order procedure (page 6-7).

Tactile Feature Knob/Lever

This option is for use in applications where special notice is needed to warn the blind about safety or accessibility environments.

Depending on the style ordered, the knob or lever will receive either grooves or knurling as the tactile feature.

To order: designate "TL" on 45H/47H knobs/levers in order procedure (page 6-7).

Visual Indicator Feature

This option adds a visual indicator for certain functions that visually reflects whether the lockset is in the locked or unlocked state. This option is available for the following functions: TD– Dormitory, IND– Intruder, INL– Intruder, L– Privacy, LT– Privacy, S– Storeroom. Visual indicator feature is standard on the H– Hotel function (page 2).

Vandal Trim

VT–Vandal trim is available in standard finish for H, J, M, N, R, and S trims in either #14 or #15 levers.

Note: Not available in single or dummy trim functions. If compliance to California Building Code Title 19 & 24 is required, the #14 lever design must be specified.

Service Equipment

ED211 Mortise Cylinder Wrench

The BEST mortise cylinder wrench and test handle is an essential dual-purpose tool. It is used primarily to install or remove BEST mortise cylinders without marring the cylinder surface finish. The single end may be used to test the lock operation, as well as aligning the throw pins. **To order specify:** ED211 mortise cylinder wrench.



ED211

ED212 Mortise Cylinder Cam Assembly Tool

Mortise cylinder cams are quickly changed with the use of this tool. Approx. length 1 3/4". **To order specify:** ED212 assembly tool.



ED212

ED221 Mortise Cylinder Thread Repair Die

Tool for rethreading 1 5/32" diameter cylinders. **To order specify:** ED221 thread repair die.

ED225 Hole Tap for 1 5/32" Mortise Cylinder

Tap tool used to rethread housing threads for 1E Mortise Cylinders. **To order specify:** ED225 hole tap.



KD316

KD316 Spanner Wrench (C54466)

All "H" locksets require the use of the KD316 spanner wrench for door mounting. This tool is include with every (10) locksets ordered. **To order specify:** KD316 spanner wrench.

Hand of Door

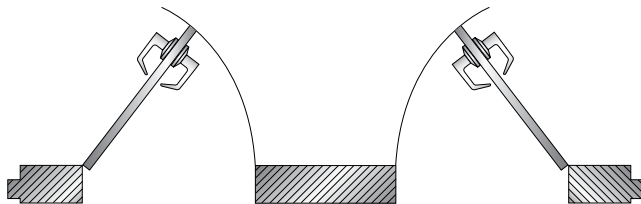

Left hand (LH)

Right hand (RH)

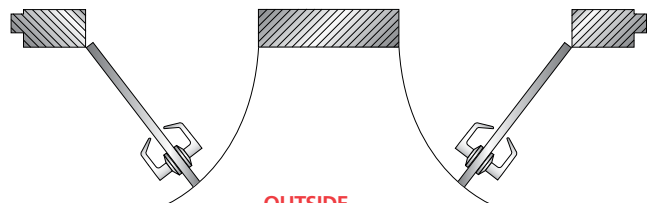

Left hand
reverse bevel
(LHRB)

Right hand
reverse bevel
(RHRB)

Mortise Sample Specifications

A. Locksets and Latchsets:

[BEST] - [_____] [_____]

1. Base Specification: BEST components as listed in Hardware Schedule per Article 3.05.
2. Locksets and latchsets of other acceptable manufacturers must conform to the requirements of Subparagraphs 3 and 4.
3. Mortise Type:
 - A. Locksets shall be tested and approved by BHMA for ANSI A156.13, Series 1000, Operational Grade 1, Extra-Heavy Duty, Security Grade 2 and be UL10C
 - B. Locksets shall be mortise type with solid 3/4 inch throw one-piece radiused latchbolt made of self-lubricating stainless steel. Deadbolt functions shall be one inch projection stainless steel construction. Both deadbolt and latchbolt to extend into lock case with reinforcing a minimum of 3/8 inch when fully extended.
 - C. Knobs to be [_____] design.
Levers to be [_____] design.
 - D. Furnish locksets and latchsets with sufficient strike lip to protect door trim.

- E. Provide locksets with 7 pin [BEST] interchangeable core cylinders. [All mortise cylinders shall have a concealed internal set screw for securing the cylinder to the lockset. The internal set screw will be accessible only by removing the core from the cylinder body with a control key]
- F. All mortise locksets and latchsets must conform to ANSI A156.13, Series 1000, Operational Grade 1 [Security Grade 2 for locksets in security areas] and be listed by UL. [High Security Option: All mortise locksets must conform to ANSI A156.13, Series 1000, Operational Grade 1, Security Grade 1 and listed by UL, and must include interchangeable core cylinders which conform to High Security Cylinder requirements of UL 437.]
- G. Locksets must fit ANSI A115.1 door preparation.
- H. Locksets and latchsets to have self-aligning through-bolted trim.
- I. Locksets and latchsets must have the ability to change handing without opening case.
- J. Auxiliary latch to be made of one-piece self-lubricating stainless steel.
- K. Locksets must be available with tactile or knurled knobs or levers for identification of hazardous areas.
- L. Lever handles must be of forged or cast brass, bronze or stainless steel construction and conform to ANSI A117.1.

Subparagraphs m through r describe quality features of BEST mortise locksets which may or may not be available from other lock manufacturers. Edit accordingly.

- M. [Spindle to be such that if forced it will twist first, then break, thus preventing forced entry.]
- N. [Knobs and levers to be operated with a roller bearing spindle hub mechanism.]
- O. [Permanent core face must be the same finish as the lockset finish.]
- P. Cylinder retaining screw, auxiliary latch, and strike must be non-handed.]
- Q. [Locking toggle on face of door must clearly indicate whether mortise lock is in the "locked" or "unlocked" state.]
- R. [Cover and armored front must interlock at the latch, preventing the cover from spreading or bowing while under duress.]

Subparagraphs s through x describe quality features of BEST mortise locksets which may or may not be available from other lock manufacturers. Subparagraphs s, t, and u should remain as a group, and subparagraphs v, w, and x should remain as a group. Choose either s-u or v-x, but not both groups.

- S. [Mortise lock to offer a complete lock (including trim) with the ability to be configured in the field to any of the following ANSI functions: F01, F04, F05, F07, F31.]
- T. [Mortise lock to offer a complete lock (including trim) with the ability to be configured in the field to any of the following ANSI functions: F19, F13]
- U. [Mortise lock to offer a complete lock (including trim) with the ability to be configured in the field to any of the following ANSI functions: F12, F20]
- V. [Mortise lock to offer a multi-function case with the ability to be configured in the field to any of the following ANSI functions: F01, F04, F05, F07, F09, F30, F31, F32.]
- W. [Mortise lock to offer a multi-function case with the ability to be configured in the field to any of the following ANSI functions: F13, F19, F33.]
- X. [Mortise lock to offer a multi-function case with the ability to be configured in the field to any of the following ANSI functions: F12, F15, F20]

40H Series - Standard Levers, Knob & Trims



Knob- 4
Rose - H



Knob- 4
Rose - R



Knob- 4
Rose - S



Knob- 4
Escutcheon - J



Knob- 4
Escutcheon - N



Lever-3
Rose - H



Lever-12
Rose - H



Lever-14
Rose - H



Lever-15
Rose - H



Lever-16
Rose - H



Lever-17
Rose - H



Lever-3
Rose - R



Lever-12
Rose - R



Lever-14
Rose - R



Lever-15
Rose - R



Lever-16
Rose - R



Lever-17
Rose - R



Lever-3
Rose - S



Lever-12
Rose - S



Lever-14
Rose - S



Lever-15
Rose - S



Lever-16
Rose - S



Lever-17
Rose - S



Lever-3
Escutcheon - J



Lever-12
Escutcheon - J



Lever-14
Escutcheon - J



Lever-15
Escutcheon - J



Lever-16
Escutcheon - J



Lever-17
Escutcheon - J



Lever-3
Escutcheon - M



Lever-12
Escutcheon - M



Lever-14
Escutcheon - M



Lever-15
Escutcheon - M



Lever-16
Escutcheon - N



Lever-17
Escutcheon - N

40H Series - Decorative Levers

#50



#51



#52



#53



#55



#60



#62



#63



#65



#69



#75



#79



#80



#81

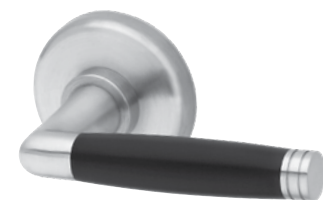

#89

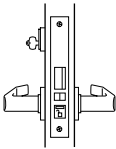
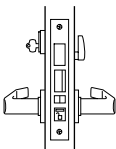
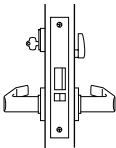
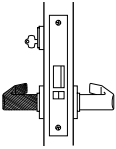
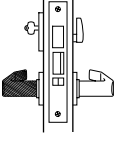
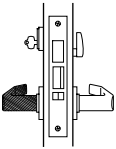
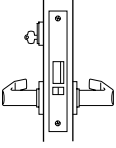

Functions

Function & Diag. (ANSI No.)	Description	Outside Lever or Knob			Inside Knob/Lever	
	Latch operated by	Deadbolt operated by	Locked by	Unlocked by	Locked by	Unlocked by
Single Keyed						
Office (A) F04 	<ul style="list-style-type: none"> Rotating inside lever, Rotating outside lever—only when locking toggle is in unlocked position, Turning key in outside cylinder. 	N/A	Placing locking toggle in locked position	Placing locking toggle in unlocked position	Cannot be locked	Always unlocked
The latchbolt is deadlocked with an auxiliary deadlatch						
Office (AB) F20 	<ul style="list-style-type: none"> Rotating inside lever, Rotating outside lever—only when locking toggle is in unlocked position, Turning key in outside cylinder. 	<ul style="list-style-type: none"> Turning key in outside cylinder, Inside turn lever, Inside lever retracts deadbolt and latch simultaneously. 	<ul style="list-style-type: none"> Placing locking toggle in locked position, Projecting dead-bolt by key or turning inside turn lever. 	Turning key in outside cylinder and placing locking toggle in unlocked position	Cannot be locked	Always unlocked
The latchbolt is deadlocked with an auxiliary deadlatch						
Office (AT) F04 	<ul style="list-style-type: none"> Rotating inside lever, Rotating outside lever only when unlocked by key or turn lever, Turning key in outside cylinder. 	N/A	<ul style="list-style-type: none"> Turning inside turn lever, Turn key in outside cylinder. 	<ul style="list-style-type: none"> Turning inside turn lever, Turning key in outside cylinder. 	Cannot be locked	Always unlocked
The latchbolt is deadlocked with an auxiliary deadlatch						
Storeroom (D) F07 	<ul style="list-style-type: none"> Rotating inside lever, Turning key in outside cylinder. 	N/A	Always locked	Cannot be unlocked	Cannot be locked	Always unlocked
The latchbolt is deadlocked with an auxiliary deadlatch						
Hotel (H) F15 	<ul style="list-style-type: none"> Rotating inside lever, Turning key in outside cylinder. 	<ul style="list-style-type: none"> Turning inside turn lever, Turning emergency key in O/S cylinder. (Rotating inside lever retracts deadbolt and latch simultaneously.) 	Always locked	Cannot be unlocked	Cannot be locked	Always unlocked
The latchbolt is deadlocked with an auxiliary deadlatch. Throwing deadbolt blocks out all keys except "ER" key.						
Hotel (HJ) F15 	<ul style="list-style-type: none"> Rotating inside lever, Turning key in outside cylinder. 	<ul style="list-style-type: none"> Turning inside turn lever, Turning emergency key in O/S cylinder. (Rotating inside lever retracts deadbolt and latch simultaneously.) 	Always locked	Cannot be unlocked	Cannot be locked	Always unlocked
The latchbolt is deadlocked with an auxiliary deadlatch. Throwing deadbolt blocks out all keys except "ER" key.						
Classroom (R) F05 	<ul style="list-style-type: none"> Rotating inside lever, Rotating outside lever only when unlocked by key, Turning key in outside cylinder. 	N/A	Turning key in outside cylinder	Turning key in outside cylinder	Cannot be locked	Always unlocked
The latchbolt is deadlocked with an auxiliary deadlatch						

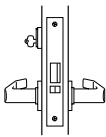
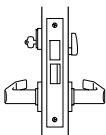
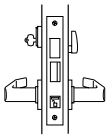
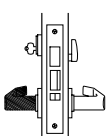
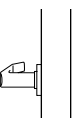
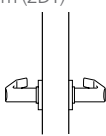
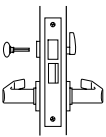
Function & Diag. (ANSI No.)	Description	Outside Lever or Knob			Inside Knob/Lever	
	Latch operated by	Deadbolt operated by	Locked by	Unlocked by	Locked by	Unlocked by
Single Keyed (continued)						
Classroom Holdback (RHB) F06 	<ul style="list-style-type: none"> Rotating inside lever, Turning key in outside cylinder, O/S lever except when locked by outside key, Latchbolt held retracted by turning O/S key while holding up I/S lever. 	N/A	Turning key in outside cylinder	Turning key in outside cylinder	Cannot be locked	Always unlocked
The latchbolt is deadlocked with an auxiliary deadlatch						
Dormitory (T) F13 	<ul style="list-style-type: none"> Rotating inside lever, Rotating outside lever—only when deadbolt is retracted Turning key in outside cylinder. 	<ul style="list-style-type: none"> Turning key in outside cylinder, Inside turn lever, Inside lever retracts deadbolt and latch simultaneously. 	<ul style="list-style-type: none"> Turning key in outside cylinder, Turning inside turn lever. 	<ul style="list-style-type: none"> Turning key in outside cylinder, Turning inside turn lever. Rotating inside lever. 	Cannot be locked	Always unlocked
Dormitory (TA) F12 	<ul style="list-style-type: none"> Rotating inside lever, Rotating O/S lever only when locking toggle is in unlocked position and deadbolt is retracted, Turning key in outside cylinder. 	<ul style="list-style-type: none"> Turning key in outside cylinder, Turning inside turn lever. (Rotating inside lever retracts deadbolt and latch simultaneously.) 	<ul style="list-style-type: none"> Placing locking toggle in locked position, Projecting deadbolt by key or turning inside turn lever. 	Turning key in outside cylinder and placing locking toggle in unlocked position	Cannot be locked	Always unlocked
Dormitory (TD) 	<ul style="list-style-type: none"> Rotating inside lever, Turning key in outside cylinder. 	<ul style="list-style-type: none"> Turning inside turn lever, Rotating inside lever retracts deadbolt and latch simultaneously.), Turning key in outside cylinder. 	Always locked	Cannot be unlocked	Cannot be locked	Always unlocked
The latchbolt is deadlocked with an auxiliary deadlatch						
Non-Keyed						
Single Dummy Trim (1DT) 	This is a single, surface-mounted lever for an inactive door or a non-latching door					
Double Dummy Trim (2DT) 	This is a through bolt mounted pair of matching levers for an inactive door or a non-latching door					
L-Privacy (F19) 	<ul style="list-style-type: none"> Rotating inside lever, Rotating outside lever only when deadbolt is retracted. 	<ul style="list-style-type: none"> Turning the emergency key, Turning inside turn lever. (Rotating inside knob/lever retracts deadbolt and latch simultaneously.) 	<ul style="list-style-type: none"> Turning inside turn lever, Turning the emergency key. 	<ul style="list-style-type: none"> Turning inside turn lever, Rotating inside lever retracts latch and dead-bolt simultaneously, Turning the emergency key. 	Cannot be locked	Always unlocked

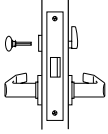
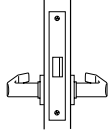
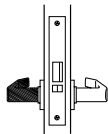
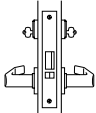
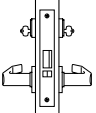
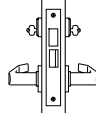
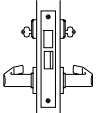
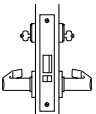
Function & Diag. (ANSI No.)	Description	Outside Lever or Knob		Inside Knob/Lever		
	Latch operated by	Deadbolt operated by	Locked by	Unlocked by	Locked by	Unlocked by
Non-Keyed (continued)						
LF-Privacy 	<ul style="list-style-type: none"> Rotating inside lever, Rotating outside lever only when turn knob is unlocked. 	N/A	<ul style="list-style-type: none"> Turning inside turn lever, Turning the emergency key. 	<ul style="list-style-type: none"> Turning inside turn lever, Rotating inside lever, Turning the emergency key. 	Cannot be locked	Always unlocked
N-Passage (F01) 	Rotating inside or outside lever	N/A	Cannot be locked	Cannot be locked	Cannot be locked	Cannot be locked
NX-Exit (F31) 	Rotating inside lever	N/A	Always locked	Cannot be unlocked	Cannot be locked	Always unlocked
The latchbolt is deadlocked with an auxiliary deadlatch						
Double Keyed						
Entrance (*C-Public) F09 	<ul style="list-style-type: none"> Rotating inside lever, Rotating outside lever only when unlocked by key in inside cylinder, Turning key in outside cylinder only. 	N/A	Turning key in inside cylinder	Turning key in inside cylinder	Cannot be locked	Always unlocked
The latchbolt is deadlocked with an auxiliary deadlatch. When required, inside cylinder may be combined to operate by master key only.						
Holdback (CHB) 	<ul style="list-style-type: none"> Turning outside key, Rotating outside lever only when unlocked by key in inside cylinder, Inside lever, Latchbolt held retracted by turning inside key while holding up on inside lever. 	N/A	Turning key in inside cylinder	Turning key in inside cylinder	Cannot be locked	Always unlocked
The latchbolt is deadlocked with an auxiliary deadlatch.						
Communicating (G) F14 	<ul style="list-style-type: none"> Latch operated from either side only when the deadbolt is retracted. 	Turning key in outside or inside cylinder	Turning key in inside or outside cylinder	Turning key in inside or outside cylinder	Turning key in inside or outside cylinder	Turning key in inside or outside cylinder
Intruder (IND) F33 	<ul style="list-style-type: none"> Turning key in inside or outside cylinder, Rotating outside lever when deadbolt is retracted, Rotating inside lever. 	<ul style="list-style-type: none"> Turning key in outside or inside cylinder, Rotating inside lever (Retracts the deadbolt and latch simultaneously). 	Extending the deadbolt by turning key in inside or outside cylinder	<ul style="list-style-type: none"> Retracting the deadbolt by turning key in inside or outside cylinder, Rotating inside lever (Retracts the deadbolt and latch simultaneously). 	Cannot be locked	Always unlocked
Intruder (INL) F32 	<ul style="list-style-type: none"> Rotating inside lever, Rotating outside lever only when unlocked by inside or outside key Turning key in inside or outside cylinder. 	N/A	Turning key in inside or outside cylinder	Turning key in inside or outside cylinder	Cannot be locked	Always unlocked
The latchbolt is deadlocked with an auxiliary deadlatch. When required, inside cylinder may be combined to operate by master key only.						

*ATTENTION: Locksets that secure both sides of the door are controlled by building codes and the Life Safety Code®. In an emergency exit situation, failure to quickly unlock the inside lever could be hazardous or even fatal.

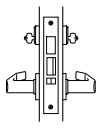
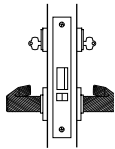
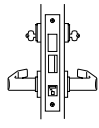
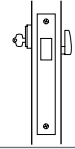
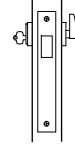
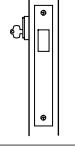
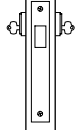
Function & Diag. (ANSI No.)	Description Latch operated by	Outside Lever or Knob			Inside Knob/Lever	
		Deadbolt operated by	Locked by	Unlocked by	Locked by	Unlocked by
Double Keyed (continued)						
Intruder (INA) F34 	<ul style="list-style-type: none"> Turning key in inside or outside cylinder, Rotating outside lever when deadbolt is retracted, Rotating inside lever. 	<ul style="list-style-type: none"> Turning key in outside or inside cylinder, Rotating inside lever (Retracts the deadbolt and latch simultaneously). 	Extending the deadbolt by turning key in inside or outside cylinder	<ul style="list-style-type: none"> Retracting the deadbolt by turning key in inside or outside cylinder, Rotating inside lever (Retracts the deadbolt and latch simultaneously). 	Cannot be locked	Always unlocked
The latchbolt is deadlocked with an auxiliary deadlatch. When required, inside cylinder may be combined to operate by master key only.						
Storeroom (*W) F30 	Turning key in inside or outside cylinder	N/A	Always locked	Cannot be unlocked	Always locked	Cannot be unlocked
The latchbolt is deadlocked with an auxiliary deadlatch. When required, inside cylinder may be combined to operate by master key only.						
Storeroom (*S) F35 	<ul style="list-style-type: none"> Rotating inside lever, Rotating outside lever only when locking toggle is in unlocked position and deadbolt is retracted, Turning key in inside or outside cylinder. 	Turning key in inside or outside cylinder	Placing locking toggle in locked position	Turning key in outside cylinder or inside cylinder and placing locking toggle in unlocked position	Extending the deadbolt	Retracting the deadbolt
Deadlocks						
Deadlock (AD) F17 	N/A	<ul style="list-style-type: none"> Turning key in outside cylinder Turning inside turn lever. 	N/A	N/A	N/A	N/A
Classroom Deadlock (RD) F29 	N/A	<ul style="list-style-type: none"> Turning key in outside cylinder Turning inside turn lever.* 	N/A	N/A	N/A	N/A
*Function RD—the inside turn knob retracts deadbolt but will not project it. (Specify hand of door.) Only for 1 - 3/4" doors.						
YD-Deadlock F18 	N/A	Turning key in outside cylinder only	N/A	N/A	N/A	N/A
WD-Deadlock F16 	N/A	Turning key in outside or inside cylinder	N/A	N/A	N/A	N/A
The latchbolt is deadlocked with an auxiliary deadlatch. When required, inside cylinder may be combined to operate by master key only.						

*ATTENTION: Locksets that secure both sides of the door are controlled by building codes and the Life Safety Code®. In an emergency exit situation, failure to quickly unlock the inside lever could be hazardous or even fatal.

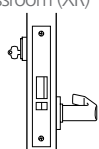
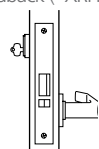
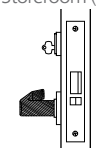
Function & Diag. (ANSI No.)	Description Latch operated by	Outside Lever or Knob			Inside Knob/Lever	
		Deadbolt operated by	Locked by	Unlocked by	Locked by	Unlocked by
Special						
Classroom (XR) 	<ul style="list-style-type: none"> Rotating inside lever, Turning key in outside cylinder. 	N/A	N/A	N/A	Cannot be locked	Always unlocked
Classroom Holdback (*XRHB) 	<ul style="list-style-type: none"> Rotating inside lever, Turning key in outside cylinder. Latchbolt held retracted by turning O/S key while holding up I/S lever 	N/A	N/A	N/A	Cannot be locked	Always unlocked
The latchbolt is deadlocked with an auxiliary deadlatch						
Storeroom (*ZD) 	Turning key in outside cylinder	N/A	Always locked	Cannot be unlocked	N/A	N/A
The latchbolt is deadlocked with an auxiliary deadlatch						

*ATTENTION: Locksets that secure both sides of the door are controlled by building codes and the Life Safety Code®. In an emergency exit situation, failure to quickly unlock the inside lever could be hazardous or even fatal.

48H/49H Series-Mortise Deadlocks

Specifications

Case: 0.095" cold rolled steel, 3 3/8" x 4 3/16" x 1". Steel is zinc dichromate plated for corrosion protection.

Faceplate: Brass or bronze material, 5 3/8" x 1 3/16" x 7/32".

Strike: Brass, bronze, or stainless steel base material.

48HS1: Flat strike supplied standard, 3 1/2" x 1 1/8" x 3/32"

Fits standard door frame cut-out as specified in ANSI A115.5.

48HS2: Lipped strike supplied as option, 4 7/8" x 1 1/4" x 3/32". Fits standard door frame cut-out as specified in ANSI A115.1.

Backset: 2 3/4"

Door Thickness: Standard lock configuration designed for doors 1 3/4" thick.

Thick door configuration available for doors up to 3" thick (specify thickness when ordering).

NOTE: "R" function not available for thick door.

Deadbolt: Stainless steel, 1" throw

Trim:

48H: Cylinder and trim ring only.

49H: M escutcheon supplied; refer to 47H specification for dimensions.

Finishes:

48H: Available in all finishes offered for 45H.

49H: Available in 626 only.



48H Series

49H Series

48H/49H Function Chart

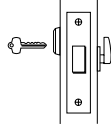
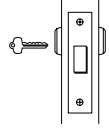
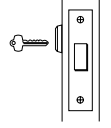
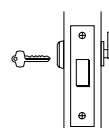
Function & Diag. BHMA#	Deadbolt operated by	Function & Diag. BHMA#	Deadbolt operated by
*K-Cylinder Deadlock  EO6071	<ul style="list-style-type: none"> Rotating the inside thumb turn rosette, Turning the outside key. 	*M-Cylinder Deadlock  EO6061	Turning the outside or inside key
*L-Cylinder Deadlock  EO6081	Turning the outside key	*R-Cylinder Deadlock  EO6091	<ul style="list-style-type: none"> Turning the outside key, Rotating the inside thumb turn cylinder assembly retracts the deadbolt, but will not project it.

*ATTENTION: Locksets that secure both sides of the door are controlled by building codes and the Life Safety Code®. In an emergency exit situation, failure to quickly retract the deadbolt could be hazardous or even fatal.

NOTE: Specify the hand of door when ordering. The R function deadlock can only be used on 1 3/4" thick doors.

How to Order - 48H/49H Series

48H	7	K	S1	626	
Series	Core Housing	Function Code		Standard Finishes	Options
48H- standard 49H- high security	0-less cylinder (48H only) 7-7-pin housing 48H accepts all BEST cores; 49H only 5C cores; 49H- 626 ONLY	K- cylinder x turn L- cylinder only M- double cylinder R- classroom cylinder x turn	S1- flat strike (default) S2- ANSI strike	48H- 605 606 611 612 613 618 619 625 626 690 49H- 626 ONLY	48H: SH- security head 49H: K- non UL cylinder

**Must specify key mark and number of keys or designate L/C for less core.

Standard Mortise Cylinder

Standard 1E74 Mortise Cylinder

Designed for standard security applications, BEST® offers the 45H/48H mortise locksets, utilizing the 1E74 mortise cylinder and special interchangeable core. Special cylinder variations are available for most applications. BEST cylinders are machined from solid brass or bronze bar stock. Additional security is provided by a set screw that mounts diagonally into the cylinder wall. This set screw prevents unauthorized removal of the cylinder without use of the control key.



1E74 Standard Mortise Cylinder

1E74 Cylinder Specifications

Diameter: 1 5/32". 1.150-32 (NS-2A) threaded mortise cylinder.

Length: 1 1/4"

Material: Brass or bronze.

Finish: Supplied to match mortise lockset trim (see specifications, page 3).

Cylinder Ring: Wrench resistant ring with tension spring, machined from all brass or bronze. Proper length automatically provided with lockset. For more ring information see cylinder catalog.

Cam: Proper cam provided for cylinder as required by designated function on order. Special cams available; see cylinder catalog section.



Standard C258 Cam All functions except O/S C and CHB

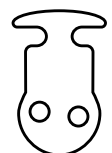

C293 Cam O/S c and CHB Functions only

High Security Cylinder

1EJ7J4 High Security Cylinder

Designed for high security applications, BEST® offers the 47H/49H mortise locksets, utilizing the 1EJ7J4 high security cylinder and special 5C interchangeable core. This special cylinder is listed by Underwriters Laboratories as conforming to Standard UL437 for high security cylinders. The patented cylinder provides additional strength through a hardened stainless steel alloy ring, face and keyway disc. It is available in most keyed functions (All functions are certified to ANSI A156.13 Security Grade 1.) and is supplied only with "M" trim. Cylinder also conforms to ANSI A156.5 Mortise Cylinder, Grade 1A.

NOTE: 1EJ7J4 must be combined at factory to comply to UL437. 1EK7K4 is combined in the field and may be ordered less core.

1EJ7J4 Cylinder Specifications

Diameter: 1 5/32". 1.150-32 (NS-2A) threaded mortise cylinder.

Length: 1 1/16"

Materials: Brass and stainless steel.

Finish: Stainless steel base plated to match 626 finish.

Cylinder Ring: High security wrench resistant, machined from stainless steel, hardened. Proper length automatically provided with lockset. Special door preparation required. Diameter of hole 1 3/4".

Cylinder Face, Keyway Disc: Stainless steel, hardened.

Cam: Proper cam provided for cylinder as required by designated function order.

NOTE: 1EJ7J4 requires long blade key for operation.



1EJ7J4 High Security Cylinder



47H Mortise Lock with #4 knob



47H Mortise Lock with #14 lever



6161 East 75th Street
Indianapolis, IN 46250 USA

Phone 855-365-2407

bestaccess.com